

MATCHED BASES AND CASINGS

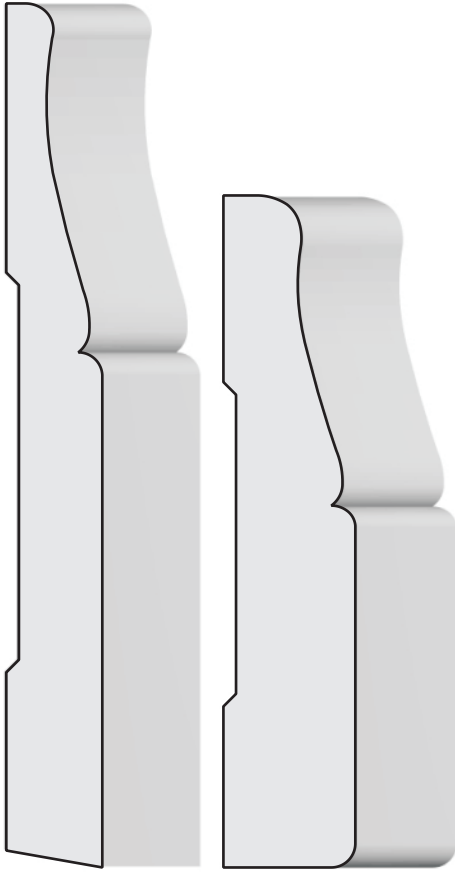

TS-BA 1
4 1/2 X 1/2

TS-CA 1
3 1/2 X 11/16

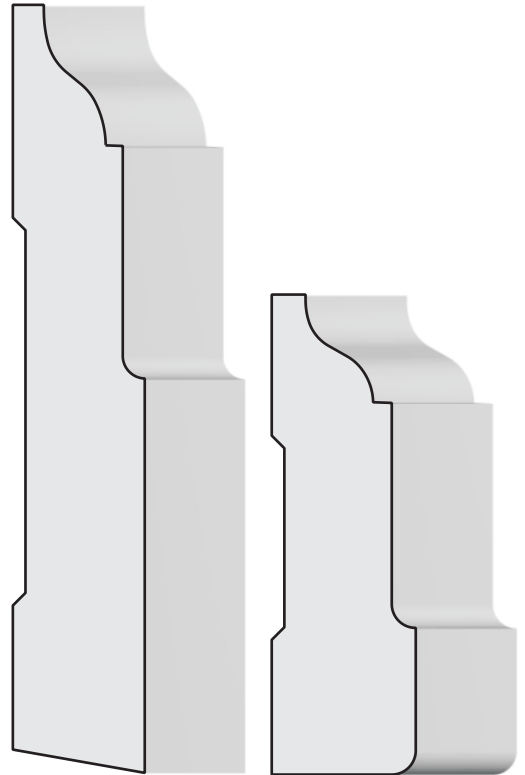

TS-BA 3
4 11/16

TS-CA 3
2 1/2 X 3/4

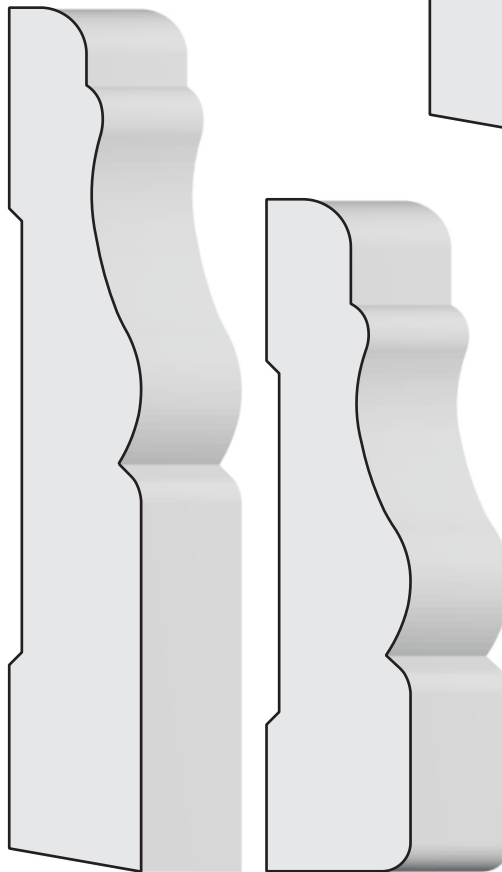

TS-BA 2
4 1/2 X 11/16

TS-CA 2
3 1/2 X 3/4

MATCHED BASES AND CASINGS

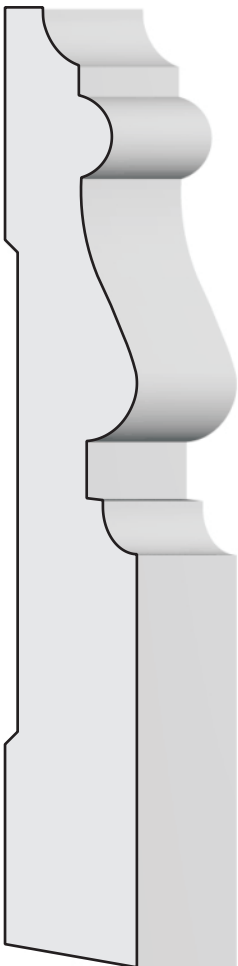

TS-BA 4
5 X 11/16

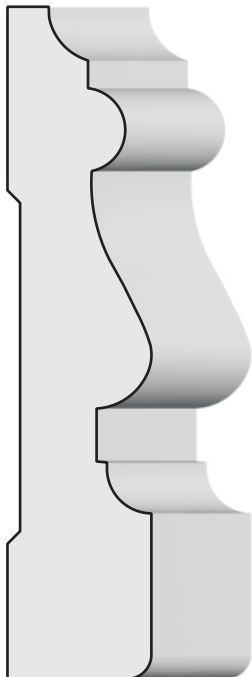

TS-CA 4
3 1/2 X 3/4

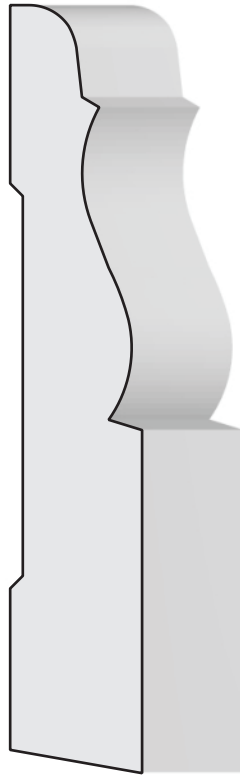

TS-BA 5
4 X 11/16

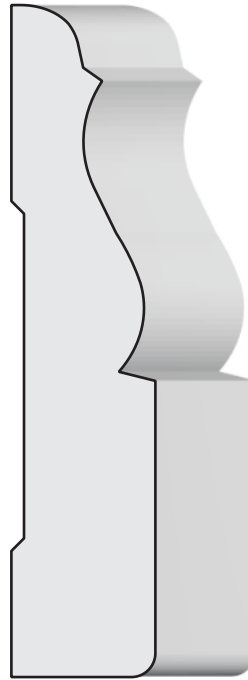

TS-CA 5
3 1/2 X 3/4

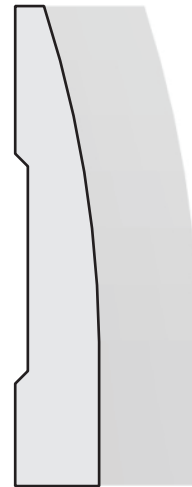

TS-BA 6
2 1/2 X 7/16

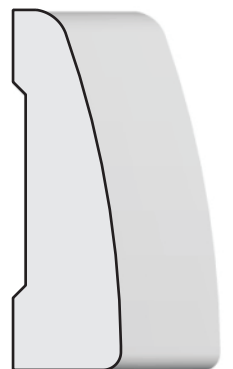

TS-CA 6
1 7/8 X 9/16

MATCHED BASES AND CASINGS

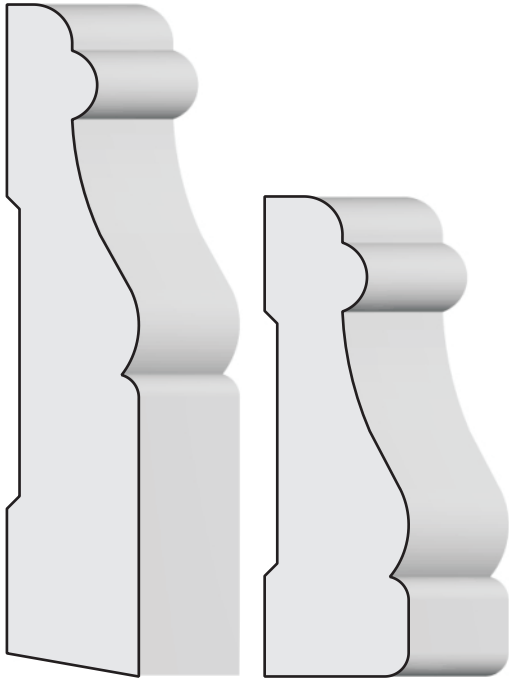

TS-BA 7
3 ½ X 11/16

TS-CA 7
2 ½ X 3/4

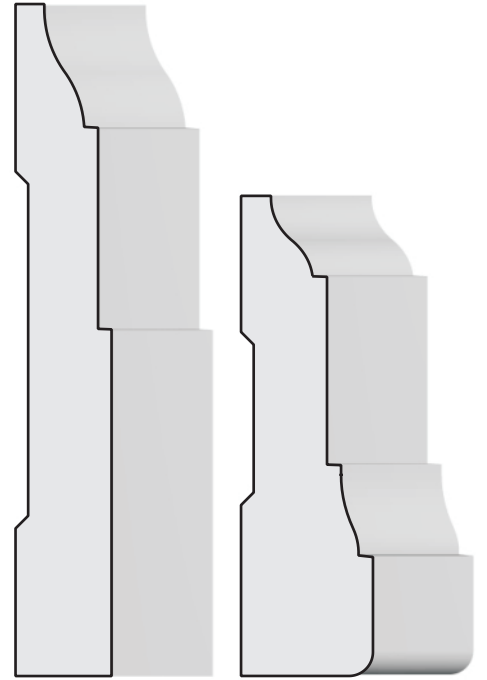

TS-BA 9
3 ½ X ½

TS-CA 9
2 ½ X 11/16

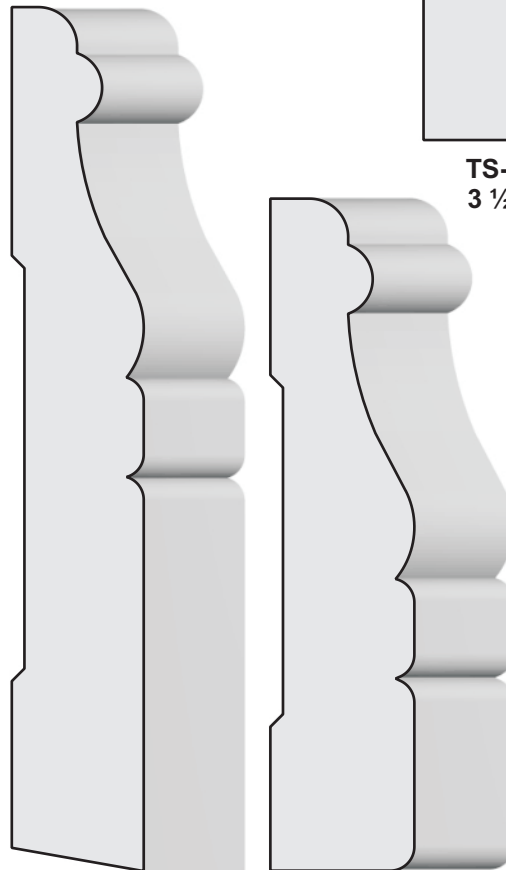

TS-BA 8
4 ½ X 11/16

TS-CA 8
3 ½ X 3/4

MATCHED BASES AND CASINGS

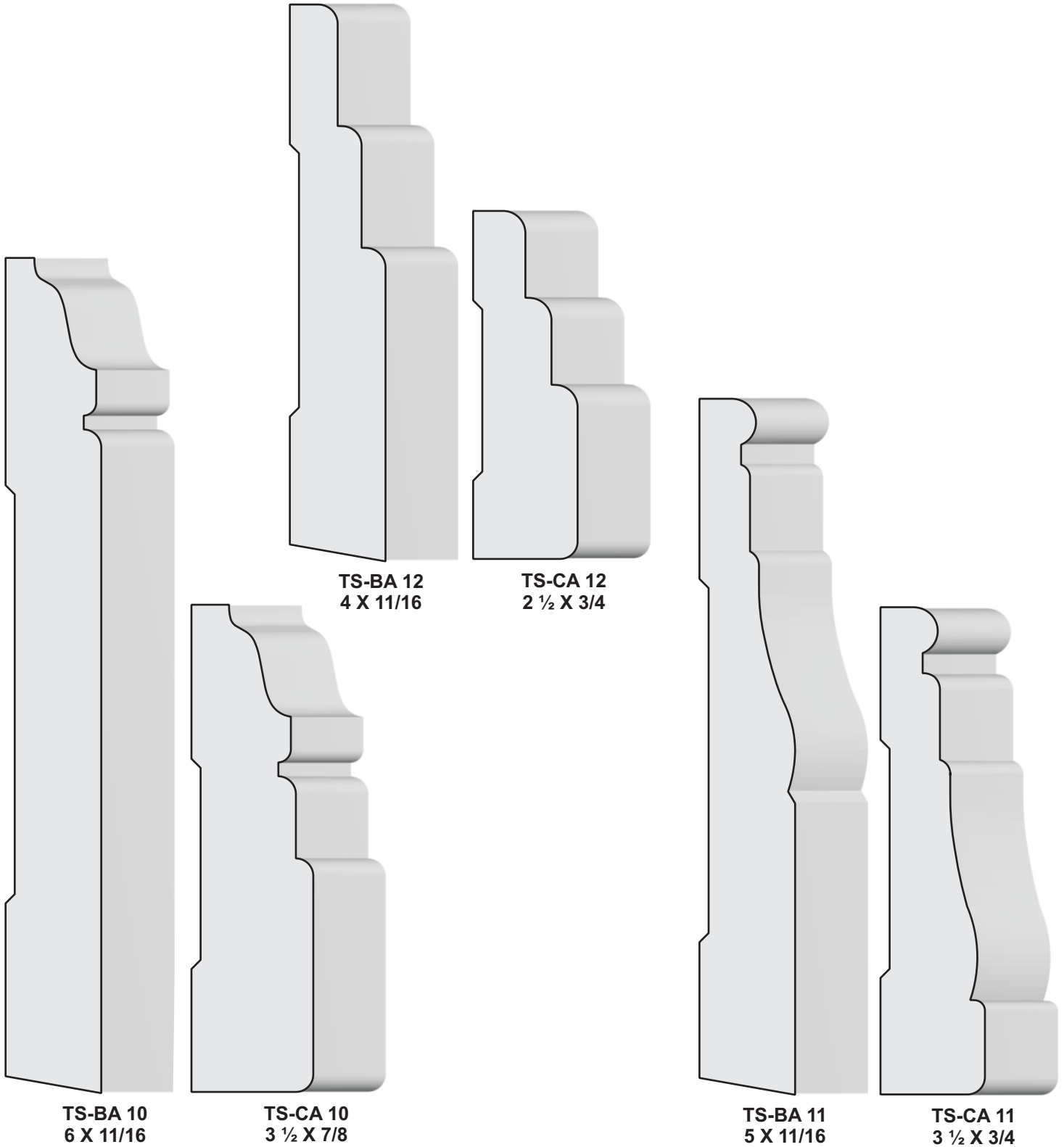

MATCHED BASES AND CASINGS

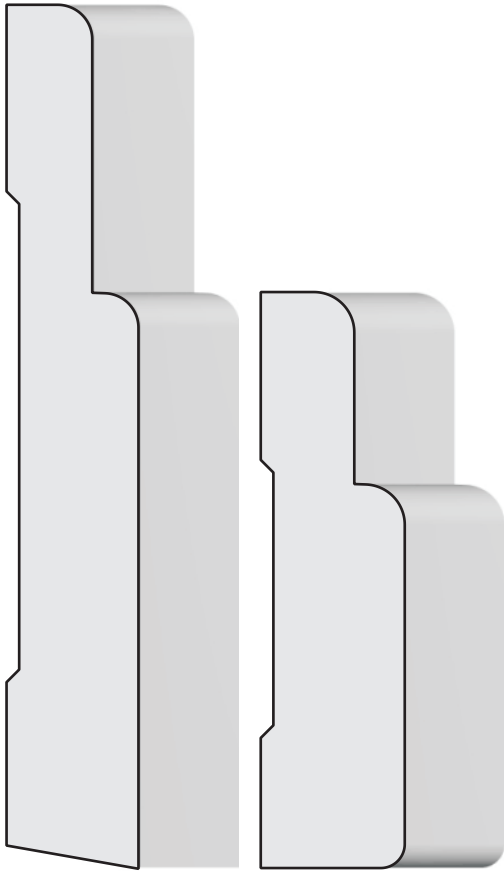

TS-BA 13
4 1/2 X 11/16

TS-CA 13
3 1/2 X 3/4

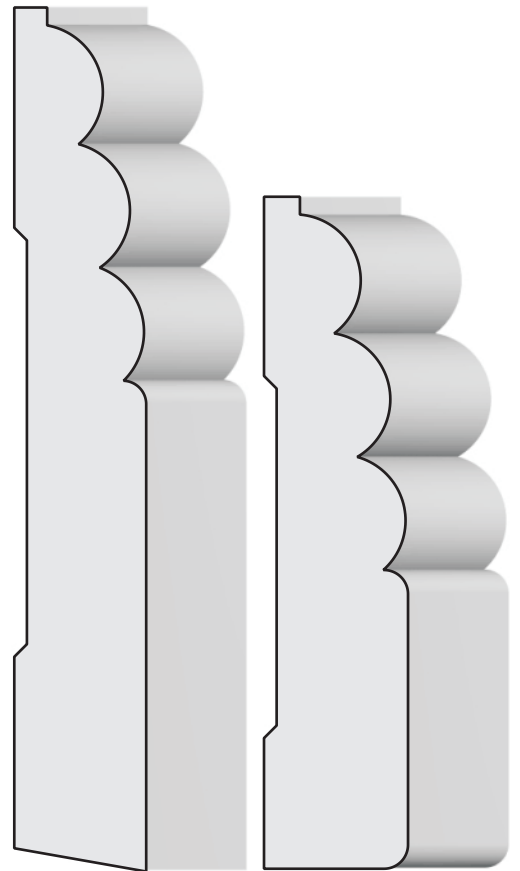

TS-BA 15
4 1/2 X 11/16

TS-CA 15
3 1/2 X 3/4

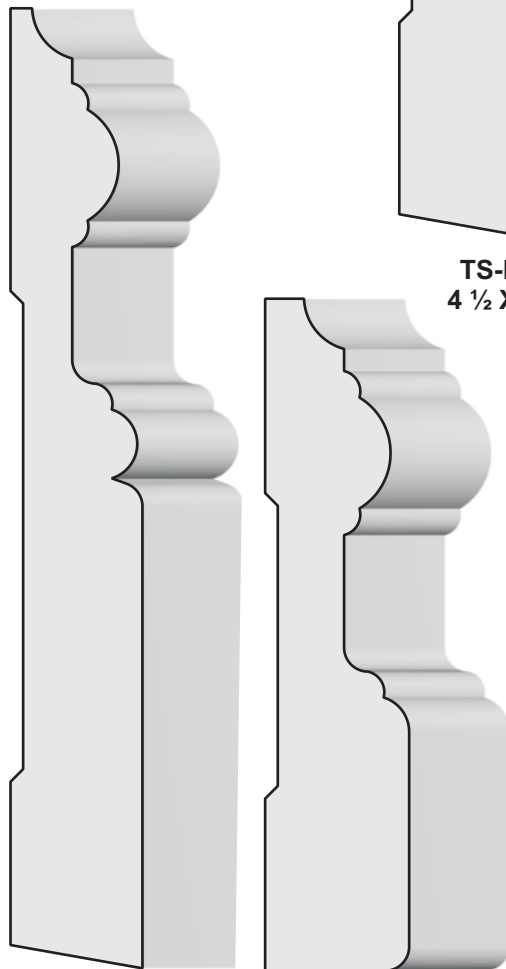

TS-BA 14
5 X 11/16

TS-CA 14
3 1/2 X 3/4

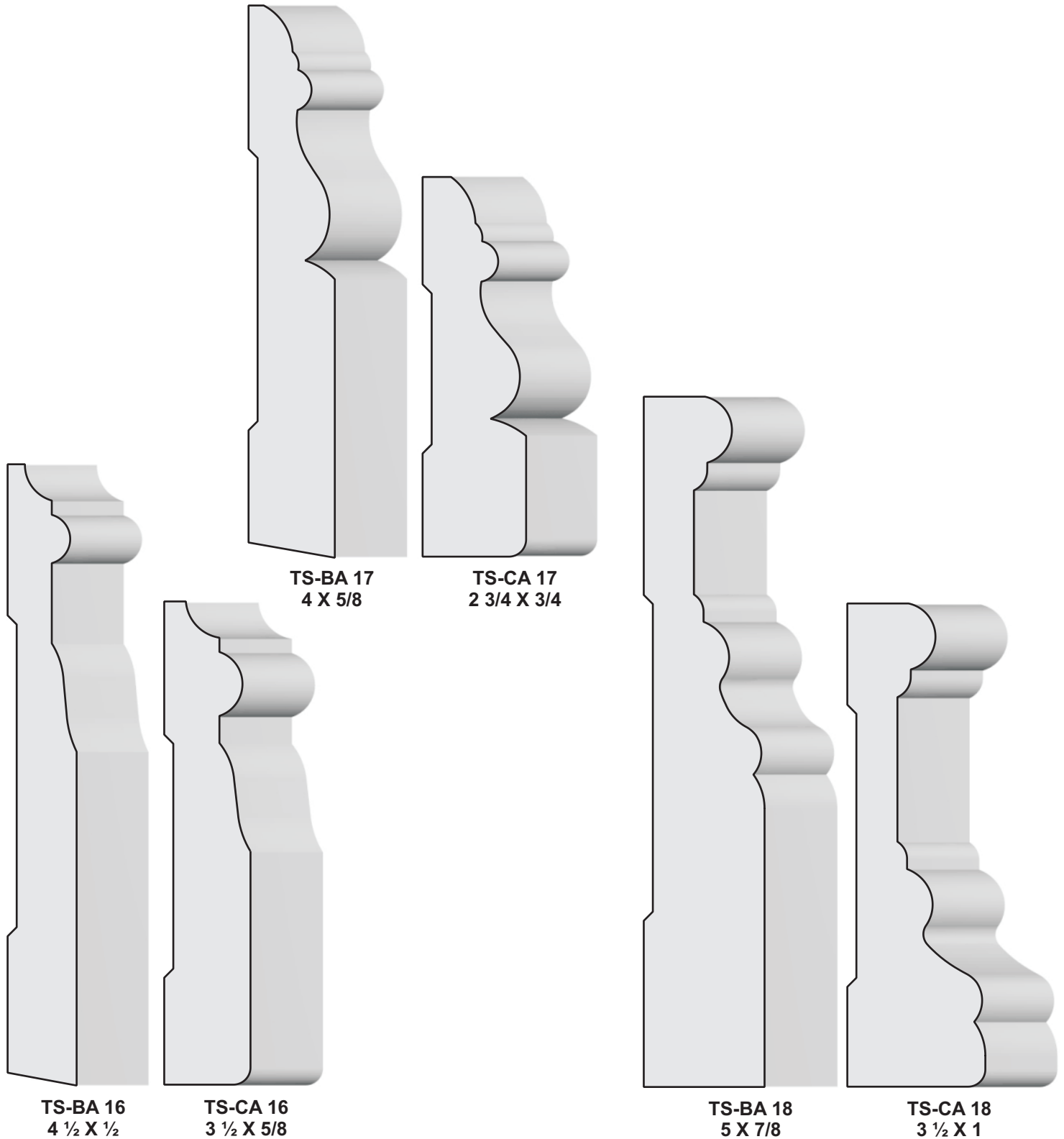

MATCHED BASES AND CASINGS

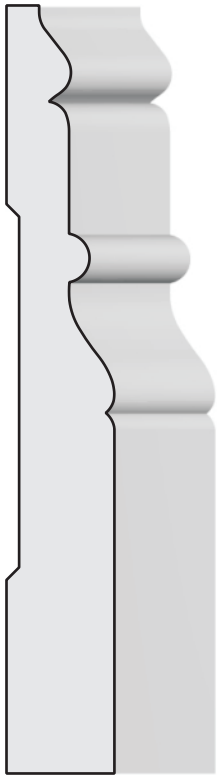

TS-BA 19
4 X 9/16

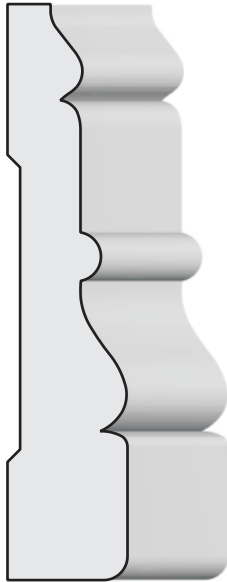

TS-CA 19
3 X 5/8

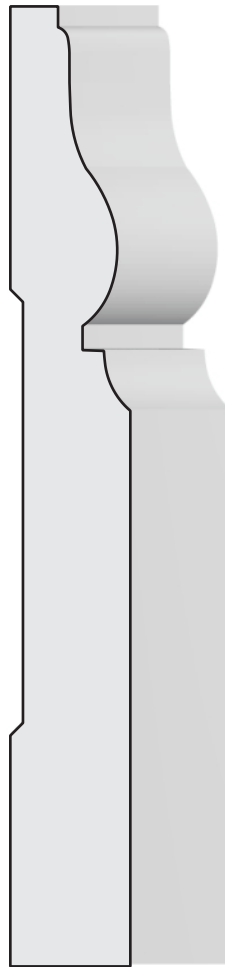

TS-BA 20
5 X 5/8

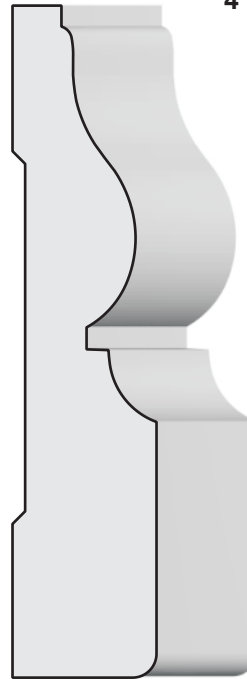

TS-CA 20
3 1/2 X 3/4

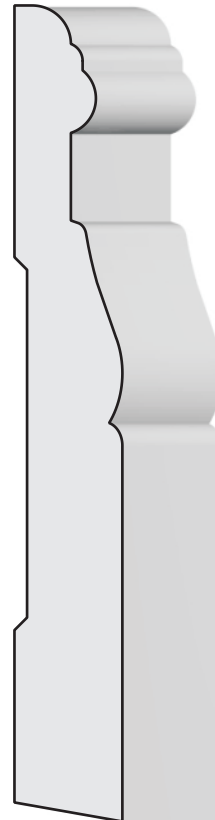

TS-BA 41
4 1/2 X 9/16

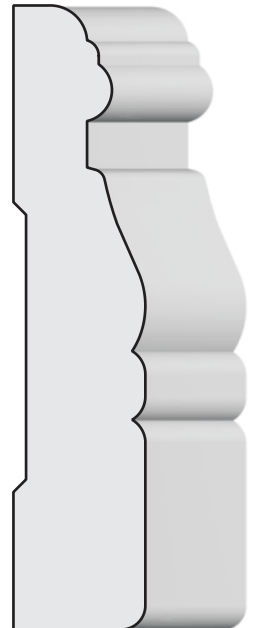

TS-CA 41
3 1/4 X 11/16

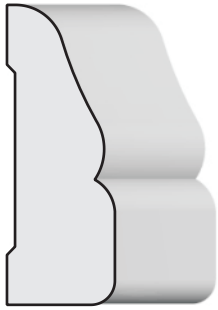

TS-CA 31
1 9/16 X 9/16

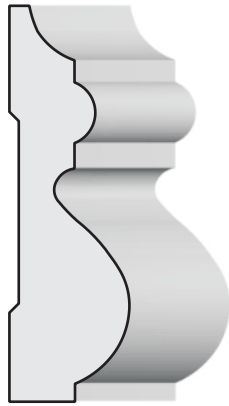

TS-CA 32
2 1/16 X 5/8

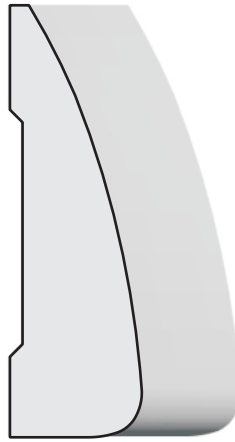

TS-CA 29
2 1/4 X 11/16

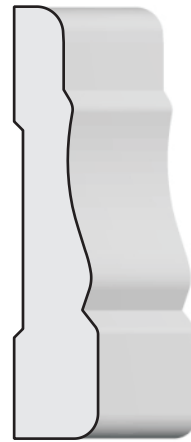

TS-CA 30
2 1/4 X 7/16



TS-CA 33
2 1/4 X 9/16

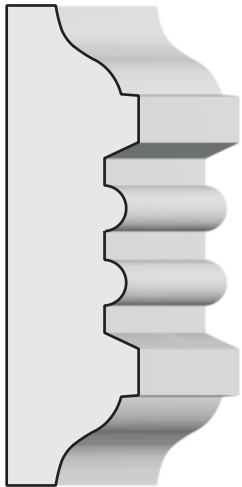

TS-CA 34
2 1/2 X 11/16

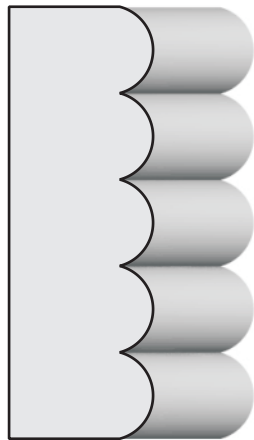

TS-CA 21
2 1/4 X 3/4



TS-CA 25
2 3/4 X 3/4

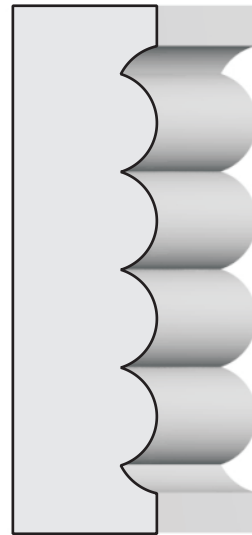

TS-CA 22
2 3/4 X 3/4

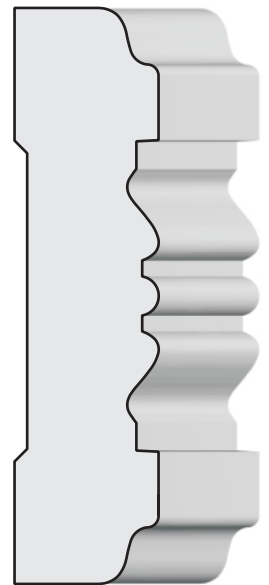

TS-CA 24
3 X 3/4

MORE CASES

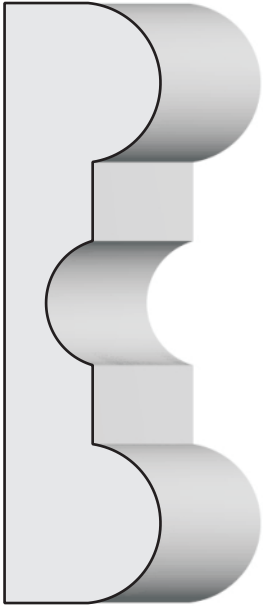

TS-CA 23
3 1/8 X 13/16

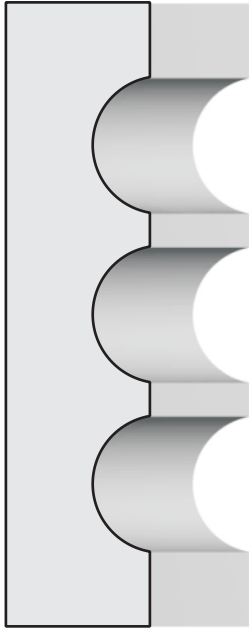

TS-CA 26
3 1/4 X 3/4

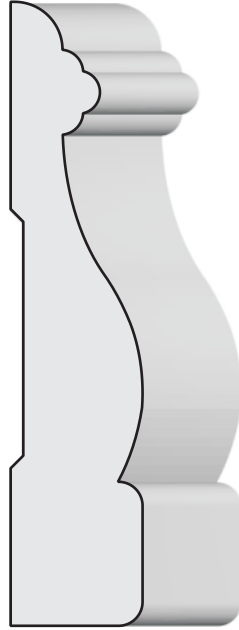

TS-CA 37
3 1/4 X 11/16

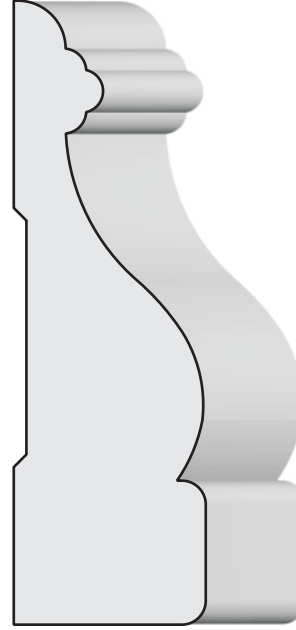

TS-CA 36
3 1/4 X 1

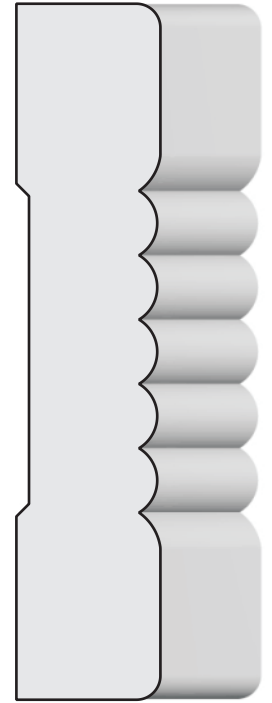

TS-CA 27
3 5/8 X 3/4

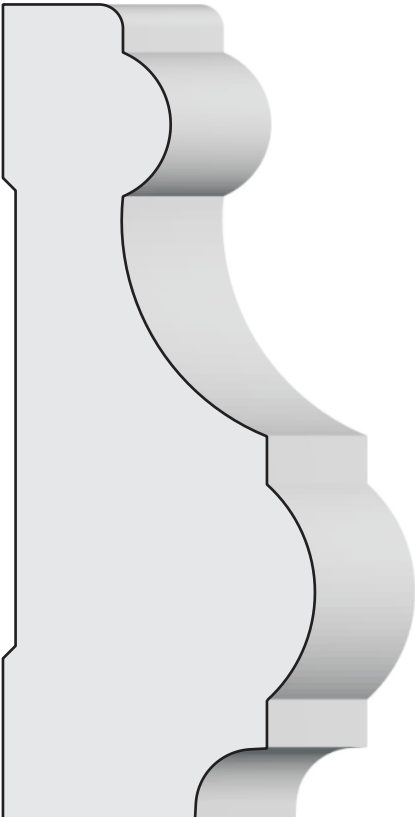

TS-CA 38
4 1/4 X 1 5/8

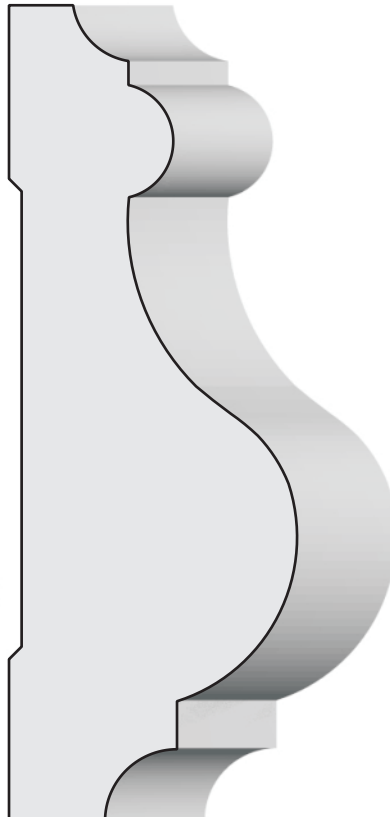

TS-CA 40
4 1/4 X 1 1/2

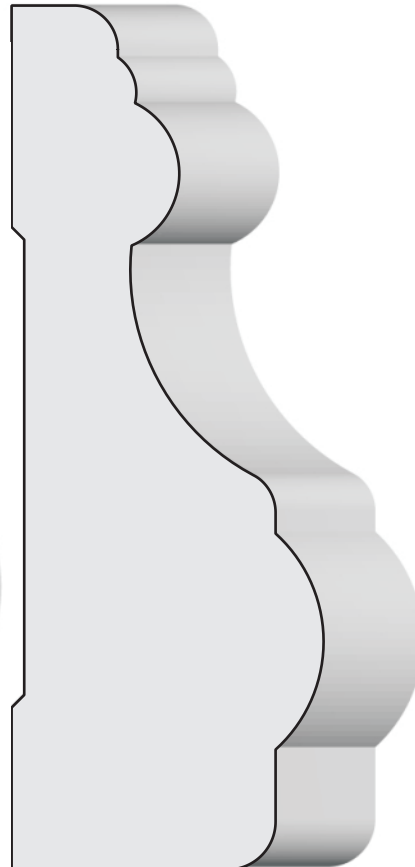

TS-CA 39
4 1/2 X 1 5/8

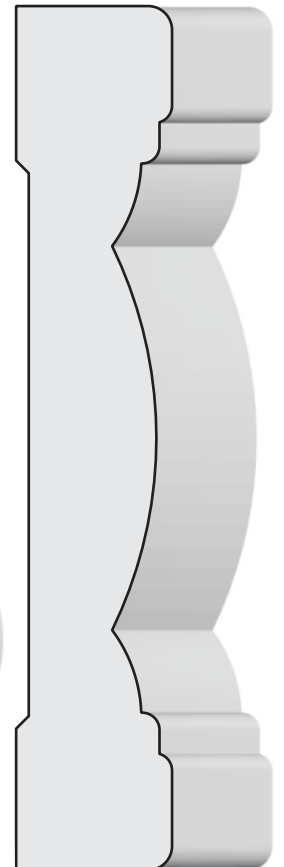

TS-CA 35
4 1/2 X 13/16